

# PARASHADE SERIES



[shelteroutdoor.com](http://shelteroutdoor.com) | 855.768.4450

**SHELTER**  
o u t d o o r







## Parashade Series

Parashade cantilever umbrellas are revolutionary and versatile with a beautiful, minimalistic design. These umbrellas are easy to use, robust, reliable, and provide a lifetime of shade backed by a manufacturer's guarantee. With parallel motion opening, tilt and gust-buster arms, these umbrellas are the perfect solution for any outdoor area.



## Available Dimensions

The fabrics are fade-resistant and waterproof and are also resistant to mildew and stains.

10' Round Canopy

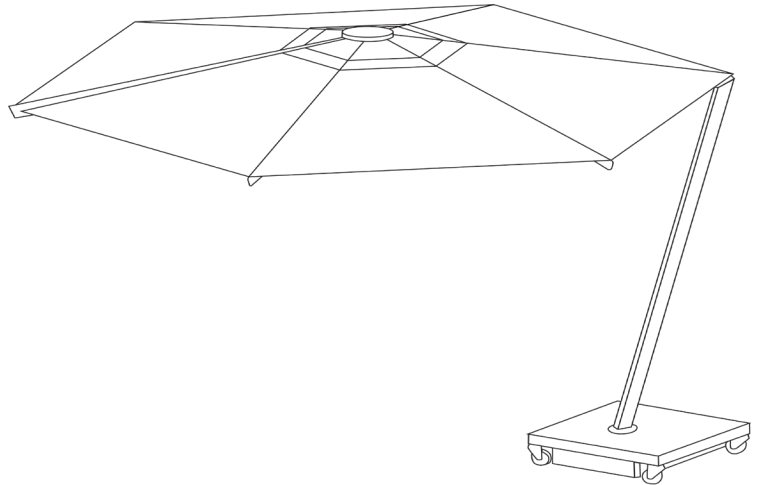

## Mounting Options

Parashade umbrellas are designed to be effortlessly mobile because it is easier to move our patio umbrellas than your patio furniture. We all know how annoying it is when the sun has moved so we engineered our umbrella bases to move effortlessly on most surfaces, but with lockable castors for safety. You can move the umbrella comfortably with one hand.



## Frame finish options

RAL Powder Coated Aluminum Frame finish options are available in two colors.



Grey



Black

## Canopy Colors

Fabrics are fade-resistant, waterproof and resist mildew and stains. UPF 50+ filters 100% of UV rays.

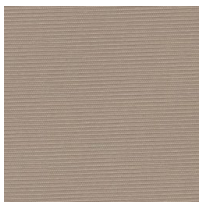

Beige

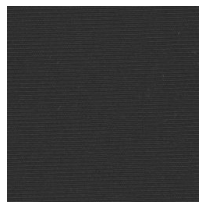

Black

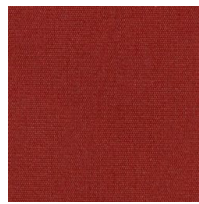

Burgundy



Captain Navy



Forest



Graphite



Light Charcoal

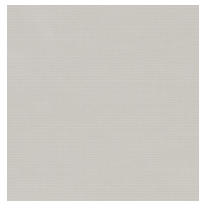

Mist



Moss

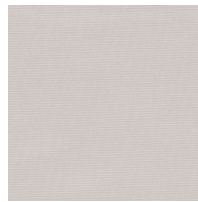

Oyster

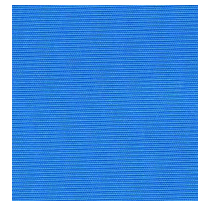

Pacific Blue



Sandstone  
Heather



Slate Heather

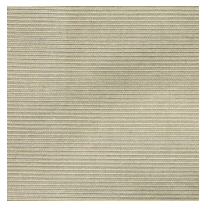

Taupe

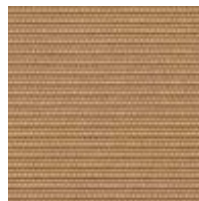

Toast

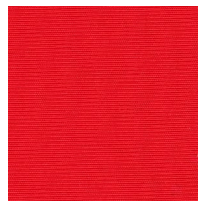

True Red

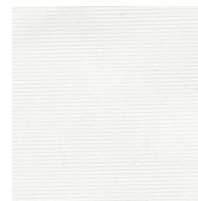

White



Yellow

## Base Options



### Steel Base + Cover

A weighted steel base and a steel cover. Ballast not included.